

Data sheet

Force transfer standard

Series KTN-Z/D

(5 N – 1000 kN)



Benefits/Application

- Class 00 according to ISO 376 in the range 10 % to 100 %
- Especially to trace back Force Standard Machines
- Insensitive against parasitic forces and moments
- Little weight
- For static tensile and compressive forces
- Hermetically sealed
- Very small force application effect
- Standardised connection dimensions

Options/Accessories

- Second redundant measuring circuit - without crosstalk at different carrier frequencies
- Temperature measurement with PT 100
- Class 0,5 according to ISO 376 in the range 10 % to 100 %
- Bending moment circuits
- Mounting parts for tension and compression

	Nominal force	F_{nom}	N	5	10	20	50	100	200	500
Metrological Data	Force measurement range		%	10 - 100						
	Interpolation error	f_c	%	0,02						
	Reversibility error	v	%	0,06						
	Repeatability error in unchanged mounting position	b, b_{rg}	%	0,023						
	Reproducibility error in different mounting positions	b', b_{rv}	%	0,045						
	Zero error	f_0	%	0,01						
	Creep		%	0,01						
	Temperature effect on characteristic value per 10 K	TK_C	%/10 K	0,01						
	Temperature effect on zero signal per 10 K	TK_0	%/10 K	0,01						
	Electrical Data	Rated characteristic value	C_{nom}	mV/V	2					
Input resistance		R_e	Ω	770 > 500						
Output resistance		R_a	Ω	700 > 450						
Insulation resistance		R_{is}	Ω	> 10^9						
Operating range of excitation voltage		$B_{U,G}$	V	5 - 12						
Protection (DIN EN 60529)				54						
Mechanical Data	Mass ¹⁾	m	kg	0,35 1,3						
	Mass ²⁾	m	kg	0,03 0,07						
	Mass ³⁾	m	kg	0,03 0,07						
	Force limit		%	110						
	Breaking force		%	200						
	Permissible eccentricity	e_G	mm	2						
	Rated temperature range	$B_{T,nom}$	$^{\circ}\text{C}$	17 - 27						
	Operating temperature range	$B_{T,G}$	$^{\circ}\text{C}$	10 - 35						

1) Force transducer

2) Compression load transmission

3) Tension load transmission

Technical data

Class 00

Nominal force		F_{nom}	kN	1	2,5	5	10	20	50	100	200	500	1000
Metrological Data	Force measurement range		%	10 - 100									
	Interpolation error	f_c	%	0,02									
	Reversibility error	v	%	0,06									
	Repeatability error in unchanged mounting position	b, b_{rg}	%	0,023									
	Reproducibility error in different mounting positions	b', b_{rv}	%	0,045									
	Zero error	f_0	%	0,01									
	Creep		%	0,01									
	Temperature effect on characteristic value per 10 K	TK_C	%/10 K	0,01									
	Temperature effect on zero signal per 10 K	TK_0	%/10 K	0,01									
	Rated characteristic value	C_{nom}	mV/V	2									
Electrical Data	Input resistance	R_e	Ω	> 500	> 1100		> 1200			> 1300			
	Output resistance	R_a	Ω	> 450	> 900		> 1000		> 1100	> 1000		> 1100	
	Insulation resistance	R_{is}	Ω	> 10 ⁹									
	Operating range of excitation voltage	$B_{U,G}$	V	5 - 12									
	Protection (DIN EN 60529)			54									
	Mechanical Data	Mass ¹⁾	m	kg	1,3		3,1		3,5	5,5	8,4	43	57
Mass ²⁾		m	kg	0,07		0,11			1,1	1,8	2,2	7,4	
Mass ³⁾		m	kg	0,07		0,11			1,3	4,2	7,7	27	
Force limit			%	110									
Breaking force			%	200									
Permissible eccentricity		e_G	mm	2									
Rated temperature range		$B_{T,nom}$	°C	17 - 27									
Operating temperature range		$B_{T,G}$	°C	10 - 35									

1) Force transducer

2) Compression load transmission

3) Tension load transmission

Cable connection

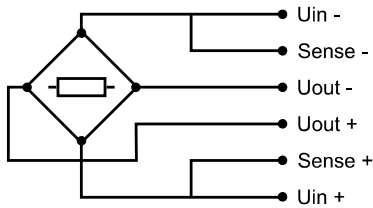

Connection pluggable ¹⁾²⁾	End not connected
7-pin LEMO Series 0 Female: - Male:	Grey cable Ø 6,5 mm 6 x 0,25 mm ² Temperature range: -35 °C bis +90 °C

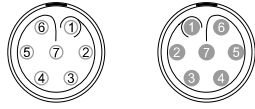

Connection		Pin	Wire colour
Supply voltage (+)	U _{in+}	3	blue
Supply voltage (-)	U _{in-}	2	black
Measurement signal (+)	U _{out+}	1	white
Measurement signal (-)	U _{out-}	4	red
Sense (+)	Sense+	5	green
Sense (-)	Sense-	6	grey
Shielding		Housing	yellow

1) View to weldingside

2) Female LEMO S.A. Typ: EGG.1B.307.CLL; Male: FGG.1B.307.CLA.D72



Pluggable cable connection
5 N to 100 N



Pluggable cable connection
from 200 N

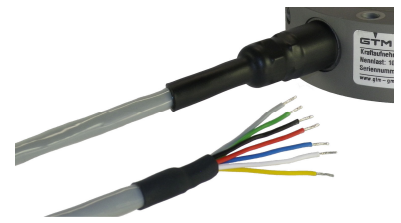
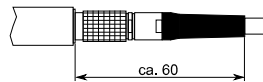

End not connected
(optional)

- Cable is not standard scope of supply
- Cable length 5 m. Other cable lengths on request
- Other connector types on cable end: D-Sub 9; D-Sub 15; M-S 7pol
- Configuration with customer defined connection is possible
- Optional fixed cable possible (from 200 N)

Option: 2.Measuring circuit

- In case of two circuits the technical data are similarly valid for both circuits
- Available from 5 kN.

Option: Bending moment

Nominal force	F_{nom}	kN	0,2 - 200 (2mV/V)
Temperature effect on characteristic value per 10 K	TK_C	%/10 K	0,2
Temperature effect on zero signal per 10 K	TK_0	%/10 K	0,2
Input resistance	R_e	Ω	400
Operating range of excitation voltage	$B_{U,G}$	V	5 - 12

- Available from 5 kN.

Mating dimensions

up to 2500 N

Size: 5 N to 100 N

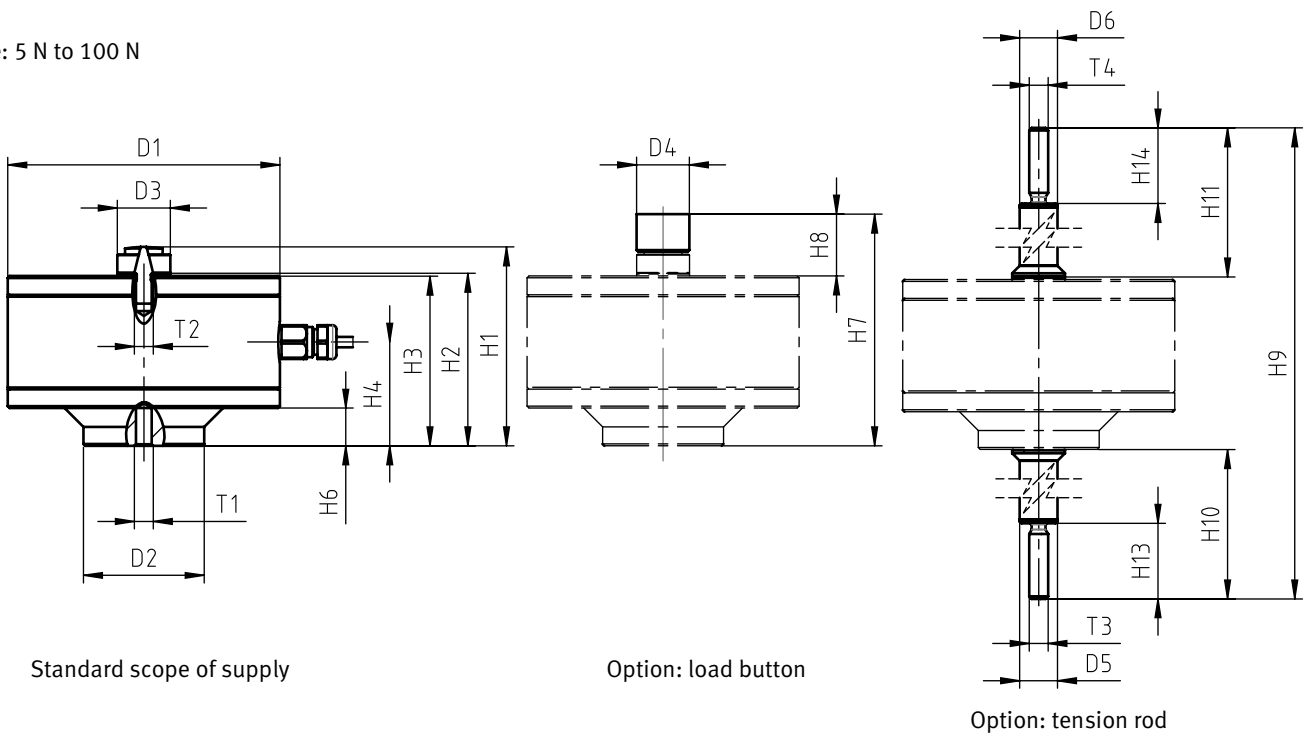

Size: 200 N to 2500 N

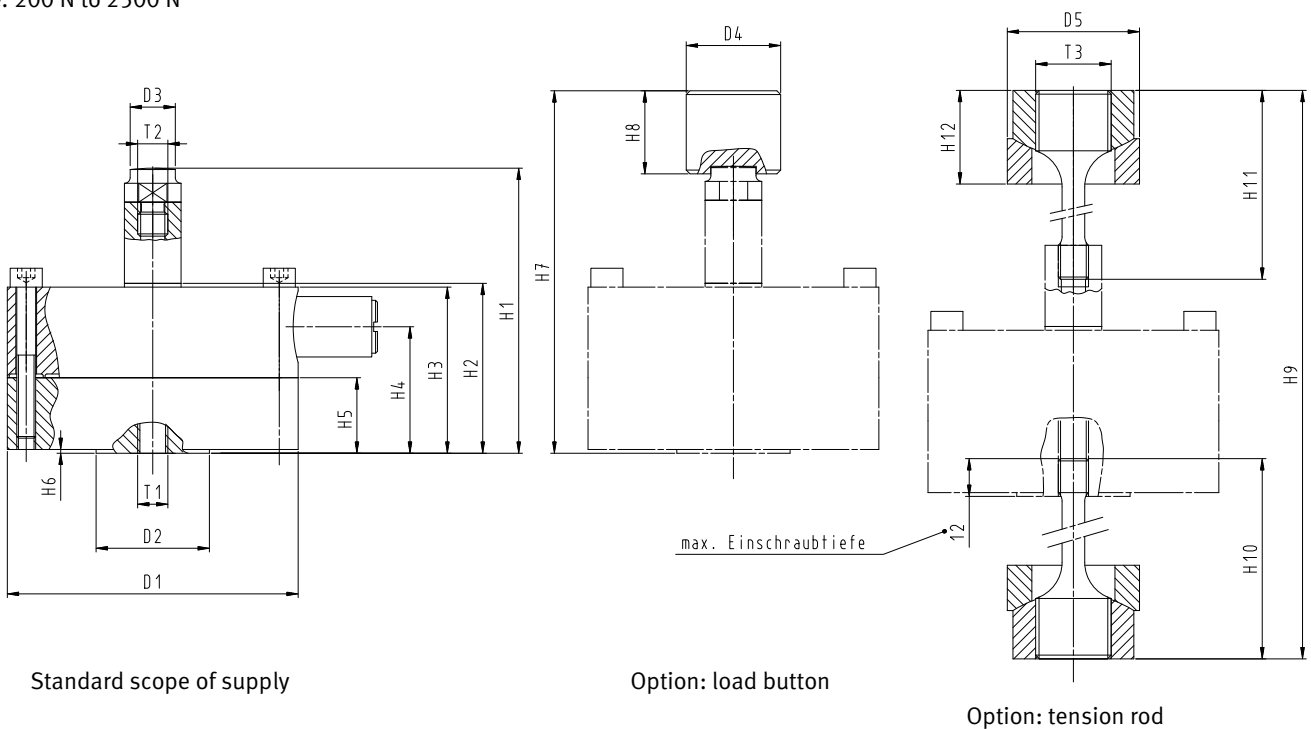

Mating dimensions

up to 2500 N

Nominal force compression/tension	$\pm F_{nom}$	N	5	10	20	50	100	200	500	1000	2500
Diameter	$\varnothing D_1$	mm			72					77	
Diameter	$\varnothing D_2$	mm			32					30	
Diameter	$\varnothing D_3$	mm			14				11,95-0,05		
Diameter	$\varnothing D_4$	mm			14					25	
Diameter	$\varnothing D_5$	mm			10					35	
Diameter	$\varnothing D_6$	mm			10					---	
Thread	T_1				M5					M8	
Thread	T_2				M5					M8	
Thread	T_3				M5					M20x1,5	
Thread	T_4				M5					---	
Height	H_1	mm			52,7					74,5	
Height	H_2	mm			45,7					44	
Height	H_3	mm			45					43	
Height	H_4	mm			27,5					32,5	
Height	H_5	mm			---					20	
Height	H_6	mm			10					1	
Height	H_7	mm			61,4					94,5	
Height	H_8	mm			16,4					22	
Height	H_9	mm			253,7					245,5	
Height	H_{10}	mm			104					100	
Height	H_{11}	mm			104					100	
Height	H_{12}	mm			---					24,8	
Height	H_{13}	mm			20					---	
Height	H_{14}	mm			20					---	

Mating dimensions

up to 500 kN

Size: 5 kN to 100 kN

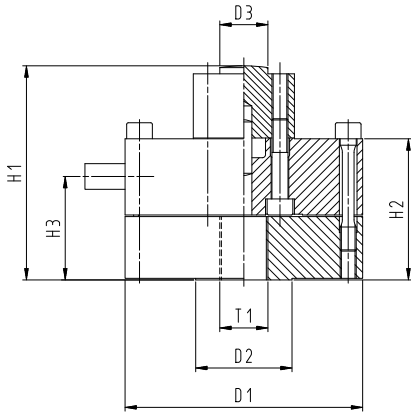

Standard scope of supply

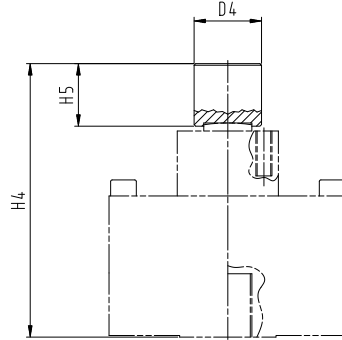

Option: load button

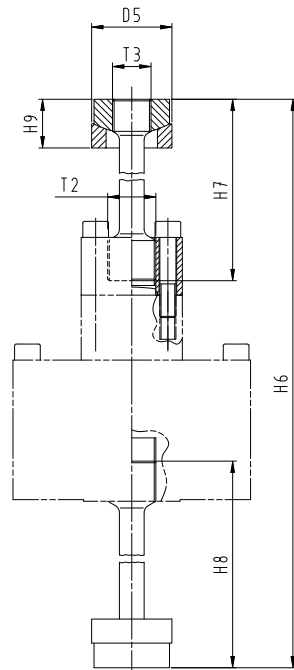

Option: tension rod

Size: 200 kN to 500 kN

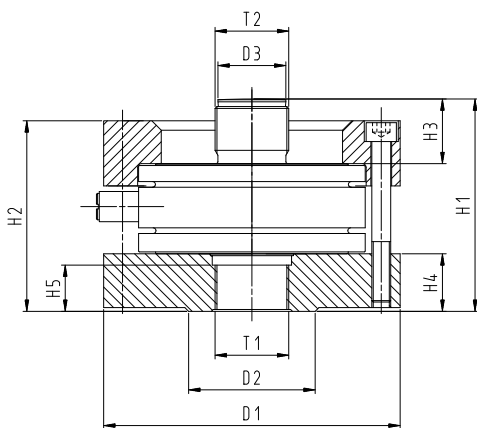

Standard scope of supply

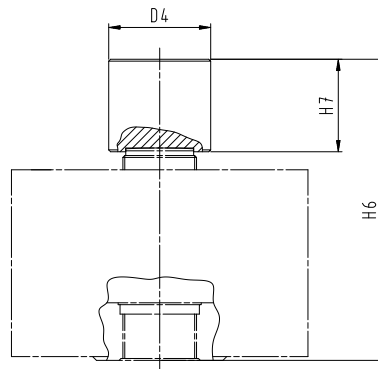

Option: load button

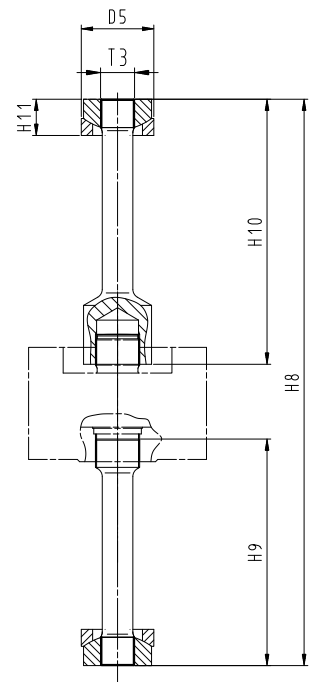

Option: tension rod

Mating dimensions

up to 1000 kN

Size: 1000 kN

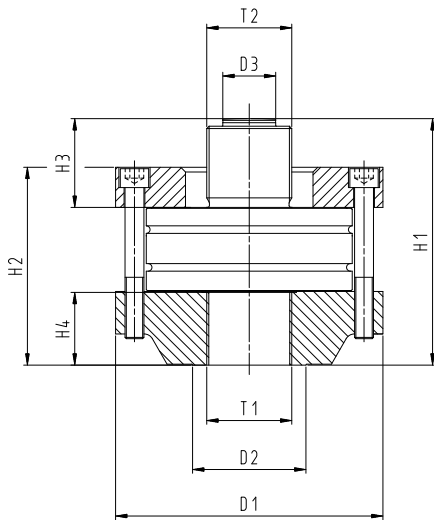

Standard scope of supply

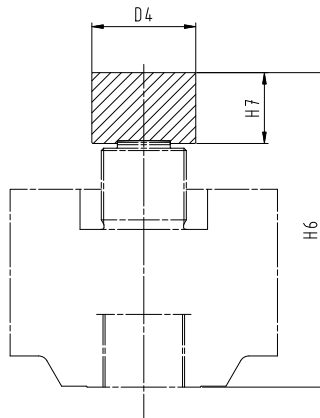

Option: load button

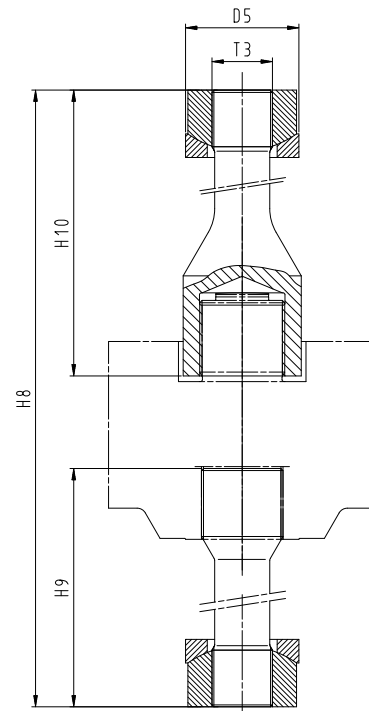

Option: tension rod

Mating dimensions

up to 1000 kN

Nominal force compression/tension	$\pm F_{nom}$	kN	5	10	20	50	100	200	500	1000
Diameter	$\varnothing D_1$	mm	77	95		101	148	157	245	283
Diameter	$\varnothing D_2$	mm	30	40		50	60	67	140	120
Diameter	$\varnothing D_3$	mm	11,95 ^{-0,05}	19,95 ^{-0,05}			25,95 ^{-0,05}	35,95 ^{-0,05}	56	
Diameter	$\varnothing D_4$	mm	25	30			42	54	110	
Diameter	$\varnothing D_5$	mm	35			45	50	64 ^{c11}	120	
Diameter	$\varnothing D_6$	mm	---							
Thread	T_1		M10x1	M20x1,5			M30x2	M39x2	M72x4	M90x4
Thread	T_2		M10x1	M20x1,5			M30x2	M39x2	M72x4	M90x4
Thread	T_3		M20x1,5			M24x2	M30x2	M64x4		
Thread	T_4		---							
Height	H_1	mm	69	88				112,5	256	261
Height	H_2	mm	46	61			89	101	218,5	209,5
Height	H_3	mm	33	48			65	34	77	94
Height	H_4	mm	89	111			171	30,5	77	
Height	H_5	mm	22	25			39	24,5	---	
Height	H_6	mm	354	374			412	159,5	328	333
Height	H_7	mm	150					49	75	
Height	H_8	mm	150					500	800	
Height	H_9	mm	24,8			25,4	30	210	356	
Height	H_{10}	mm	---					234	342	346
Height	H_{11}	mm	---					32	71,4	

Änderungen vorbehalten. Alle Angaben beschreiben unsere Produkte in allgemeiner Form. Sie stellen keine vereinbarte Beschaffenheit im Sinne des § 434 Abs. 1 BGB dar.



GTM Gassmann Testing and Metrology GmbH
 Philipp-Reis-Straße 6, 64404 Bickenbach, Germany
www.gtm-gmbh.com
 Phone +49(0)6257-9720-0, Fax +49(0)6257-9720-77
contact@gtm-gmbh.com