

EDDY CURRENT PROBES



Content:

TX Series

Key-Features:

- Linearisation with a digital gauge as reference
- High resolution (submicrometer)
- High dynamics (124 kSa/s)
- Minimal temperature coefficient
- Configurable analogue output
- CAN-Interface
- USB-Interface
- eddylab Windows software with oscilloscope, FFT, data logger, waterfall, reference and rpm-function
- Measuring ranges up to 10 mm
- Protection class IP68
- High noise immunity
- Custom-made probes

For more than ten years we have been occupied with the development and production of high-quality eddy current probes for industry and research. With the new TX Series, eddylab is introducing a fully digital device - incorporating USB, CAN and a high-speed analogue interface.

Eddy current probes are particularly suitable devices for non-contact measurements on metallic targets. Typical applications are measurements on rotating shafts for the detection of imbalance, vibration, out-of-roundness, air gap, radial/axial run-out, and much more besides. The extremely high resolution up to a level of 50nm enables the smallest of amplitudes to be detected. eddylab probes are designed for temperatures up to 185 °C, and are optimised for the entire temperature range with regard to temperature drift.

The basic principle

The principle of measurement bases on a DSP-driven oscillating circuit made up of the probe (inductance) and a interconnect capacitance. This circuitry is attenuated in the presence of metallic objects. The oscillating circuit generates magnetic field lines - these induce eddy currents on the surface of conductive objects. The eddy currents counteract their cause and attenuate the amplitude of the oscillating circuit. This effect is decoupled from the oscillating circuit and fed towards further signal processing.

Outstanding temperature coefficient - Zero TC

A remarkable feature is the TX-Serie's temperature coefficient (TC). The temperature coefficient is optimized in a range between -60 °C..185 °C. For certain boundary conditions the position will be constant at ambient temperature and 150 °C. This matter of fact can interpreted as a Zero TC. Particularly when it comes to high-resolution measurements this effect is of seminal importance.

Minimal probe drift

Every probe produced in eddylab's facility line is treated with a thermal finishing procedure of 12-hours duration (burn-in). This procedure minimises aging and drift. The probe is then finally calibrated in our laboratory before delivery.

Eddy Current Model Illustration

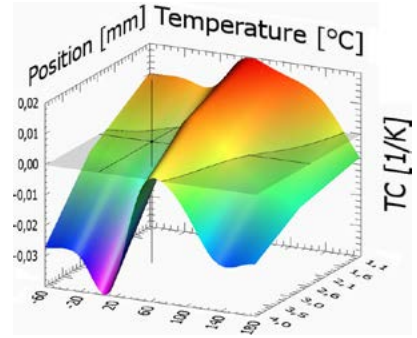
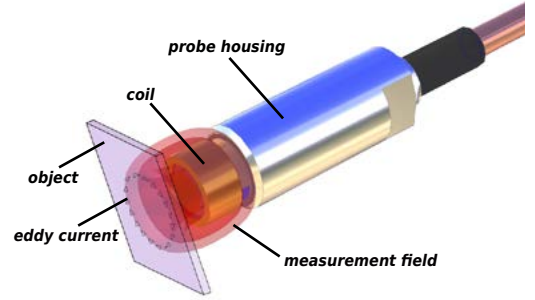

APPLICATIONS

High-resolution distance measurements on metallic objects regardless of non-conductive mediums in the measurement area. Examples are polymers, glass, oil, water, dirt. Measurement of thermal expansion with a maximum resolution of 50nm.

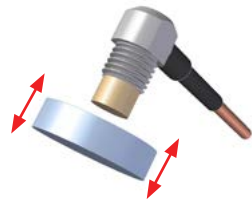

Thickness measurement of sheet material and foils. Two-sided measurement for thickness measurement. Controlling of machinery (feed-back, closed-loop).

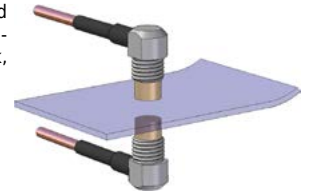

Measurement of vibration and oscillation on rotating shafts. Measurement of out-of-roundness and radial displacement. Surveillance and monitoring of rotating mechanical components. Bearing wear and lubrication gap.

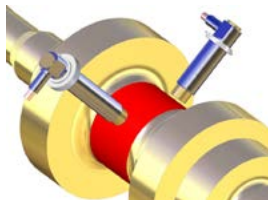

Weld seam positioning via edge detection. Welding torch tracking. Surveillance of weld seams. Out-of-roundness measurement on welded drums and tubes.

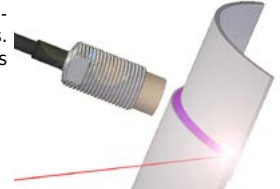

Deformation and oscillation of gearwheels in operation. Axial thrust measurement of helical cut gears under load. Detection of tooth loss on gearwheels.



Housing deformation of machines under load such as gearboxes, engines, turbo generators. Measurement of torsion on shafts and housing. Measurement of thermal expansion.



Inspection and part quality analysis during production in the presence of cooling lubricant. Detection of gearing. Groove detection. Detection of flat portions on shafts.

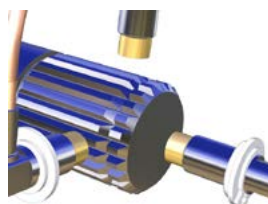

Distance-time diagram for measurement probes covered on the side. The measured object passes by the probe laterally. Measurement of object acceleration and deceleration.

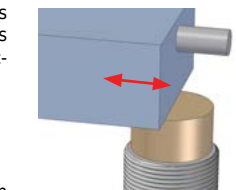

Layer thickness of non-conductive material such as powder coatings and paint. Inspection of plastic injection-moulded parts at insert moulded metal parts.

.....and many more

EDDY CURRENT BASIC MODULE TX

The processor based design admits linearities less than 0.1% - which is an exceptional feature for this sensor technology. Remarkable performance allows highly dynamic measurements with 124 kSa/s.

The TX-Driver is available as single- or dual-channel device. As standard, the device provides a USB and a CAN-bus Interface. The power supply is a galvanically isolated wide input from 10.5..36 (27) VDC.

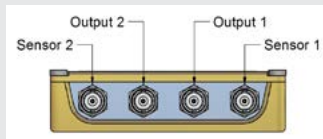

Probe and analogue output:
isolated output and high-speed signals via BNC connector. Selectable output signals 10 V, 5 V, ± 5 V, 0...20 mA, 4...20 mA.

Benefit 2-channel unit:
2 different probes can be connected to one TX-driver.

Benefit 1-channel unit:
highest dynamic performance. The output sampling rate is 124 kSa/s.

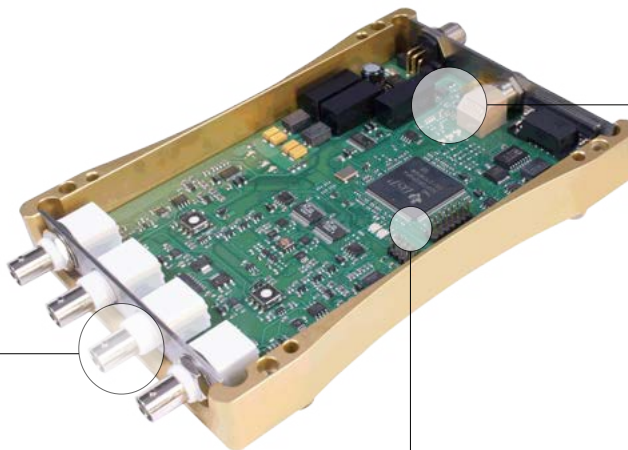
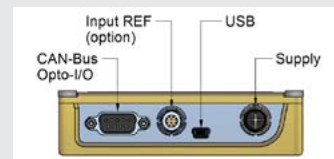

Illustration shows the 2-channel unit

Processor linearised signal conditioning
- linearisation and calibration with 50 points
- high dynamic performance with selectable digital filter
- high resolution and precision



Supply:
Wide-Input-supply 10,5...36 (27) VDC, screwable M12 connector for shielded cables; galvanically isolated.

CAN-Bus:
Data transfer via CAN bus for diverse systems with multi channel measurement.

USB connection:
Interface to PC and data transfer. Usage of eddylab software. Direct communication via USB protocol.

Reference input:
Optional high-speed counter for linearisation- and rpm-function (eddylab reference).

CUSTOM MADE

Extended measurement ranges

The powerful TX-Driver admits customisation of our probes to your needs. The measurement range can be extended up to 50 % - depending on the probe.

X-Z system

Axial thrust measurements on shafts without face access can be performed with the X-Z system. The radial and the axial displacement can be measured on the lateral side.

Pressure-resistant probes

In accordance with your needs we also produce pressure-resistant probes in stainless steel and ceramics. These probes can be applied in absolute and differential-pressure systems.

Water cooled

When it comes to ultra-hot conditions we offer probes with integrated cooling channels for connection to a cooling system.

Custom-Made

If your application requires non-standard dimensions we also produce shortened and extended housing as shielded and non-shielded probes.

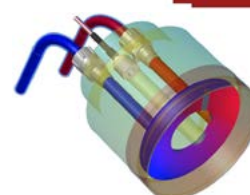
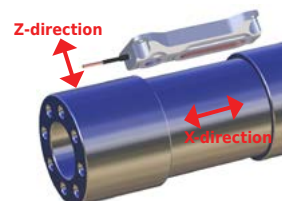
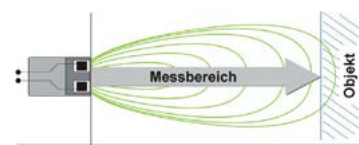

eddylab SOFTWARE

eddylab - Windows Analysis Software via USB

eddylab 2.0 standard is a powerful windows software various functions: **Oscilloscope - FFT - Waterfall - Data logger.**

The sampling rates are 38 kSa/s for a single-channel device and 22.5 kSa/s for a dual-channel device. Furthermore eddylab is used to configure the TX-Driver. A new feature is the possibility to linearise eddy current sensors on-site.

Oscilloscope

Sampled data is displayed with basic measurements in the style of a classical oscilloscope.

- single- and dual-channel oscilloscope. Samplingrates: 38 kSa/s (single); 22.5 kSa/s (dual)
- AC/DC-coupling
- variable time base 14ms...5sec
- scaleable Y-axis & autoscale function
- user-defined trigger level, hysteresis and pre-trigger, trigger source, falling and rising edge
- essential measurements on dynamic data can be taken: amplitude, frequency, max & min values
- data export as image (bmp) and text file

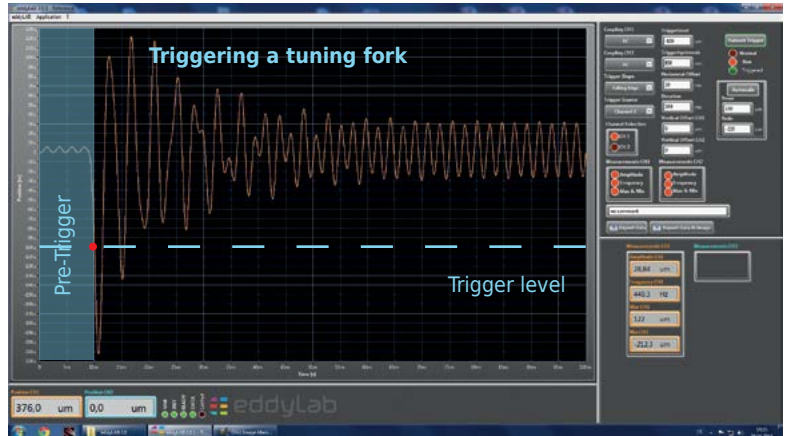

FFT analyser

Fast-Fourier transformation. Spectral analysis of mechanical motion. Analysis of fundamental oscillation and harmonics.

- visualisation of the frequency spectrum up to 19kHz (single-channel); 11.25kHz (dual-channel)
- threshold value for frequency detection can be selected
- detection of frequencies and amplitudes
- scalable frequency axis
- data export as image (bmp) and text file

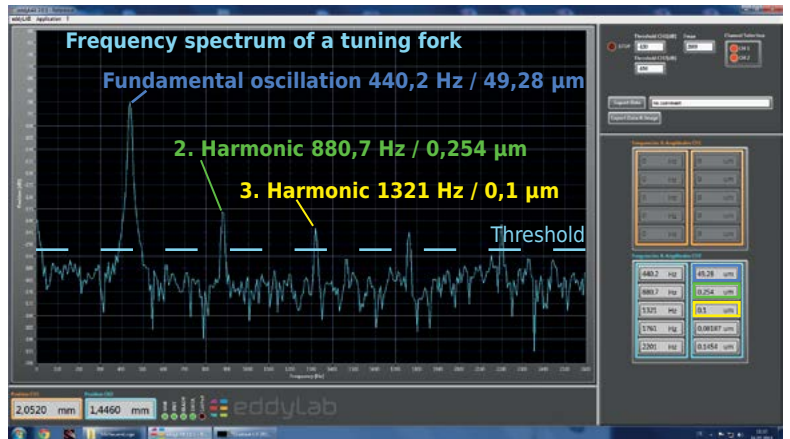

Data logger

Record of measured data and storage on hard drive.

- user-defined sampling rate: 100 ms...10 s
- time base 1 min...60 min
- data export as image (bmp) and text file

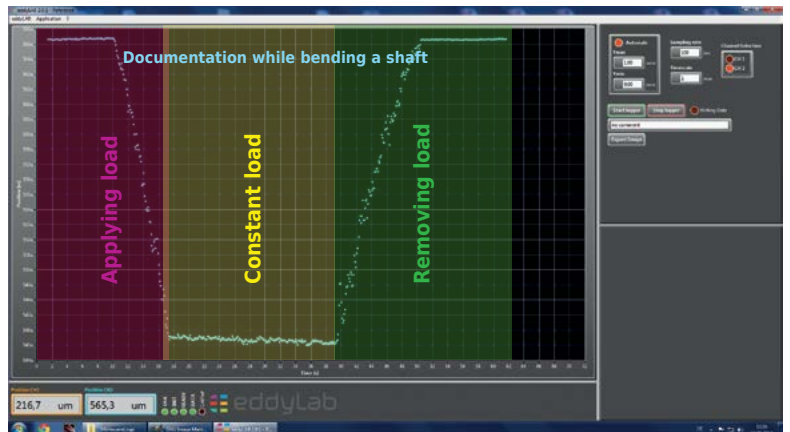

Waterfall

The FFT is expanded with a time axis. The 3D-plot provides a new view to your spectrum as it can be observed over time. The third axis emphasizes small peaks above the noise floor. In particular when these small peaks emerge and disappear over time.

- spectrum like the two-dimensional FFT expanded with a time axis
- scalable frequency axis
- 3D-view can be rotated
- movable analysis plane along the time axis
- detection of frequencies and amplitudes within the analysis plane
- export as image

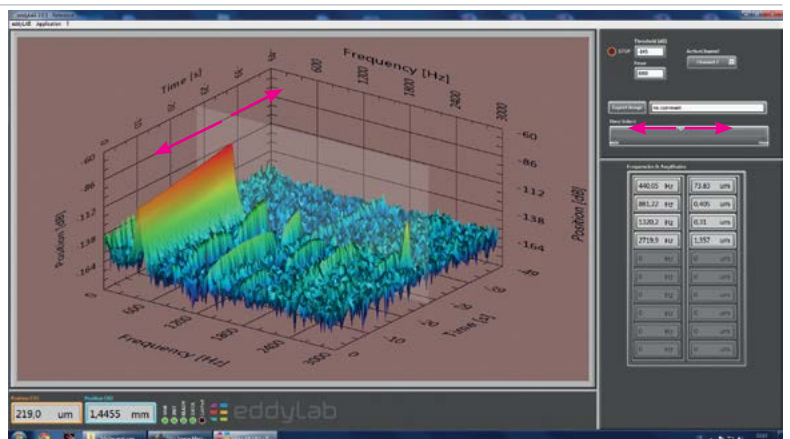

SOFTWARE eddylab 2.0 Reference

eddylab 2.0 reference is powerful windows software with additional features. These are the linearisation and the rpm-based waterfall. eddylab reference requires a reference input on the TX-Driver.

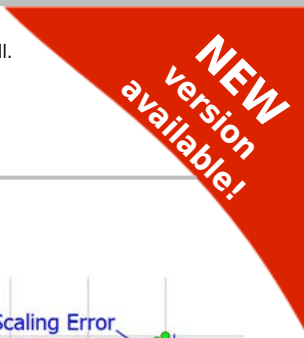

Calibration and linearisation

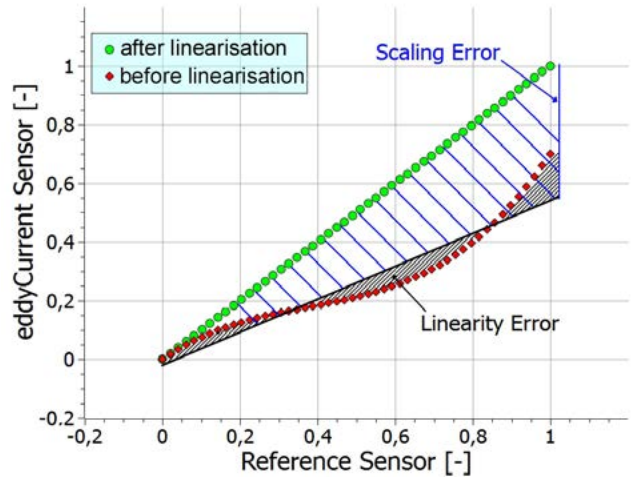
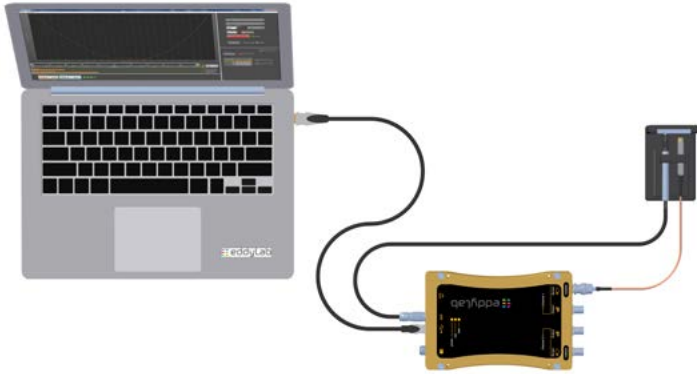

Linearisation:

A well known issue when it comes to eddy current measurements is the strong sensitivity to varying target material and pre-attenuation. The maximum scaling error under varying material can be 20% or more. The linearity error can be 7% or more. Another severe error source affecting the accuracy is pre-attenuation. This effect has to be taken in account when the sensor is mounted in narrow gaps and holes. The error due to pre-attenuation is hard to predict - but in most cases higher than expected. The TX-Driver in conjunction with eddylab resolves the issues with an integrated linearisation procedure.

The backbone of the method is an interface to a linear encoder on the TX-Driver. The encoder is used as a reference signal. The reference can be used to either prove the accuracy of the sensor or to linearise the sensor. The linearisation is based on a user defined number of positions. The TX-Driver is capable of storing four user defined curves. In order to align the eddy current sensor with the linear encoder we provide a portable linear stage with a micrometer screw. This enables a linearisation on-site.

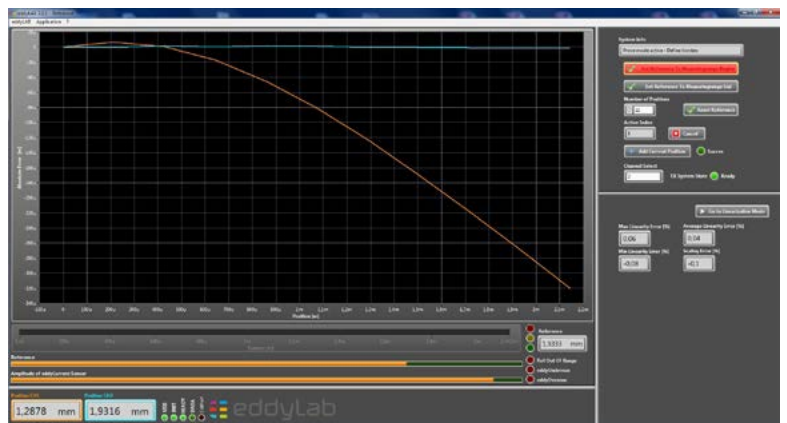

Waterfall RPM

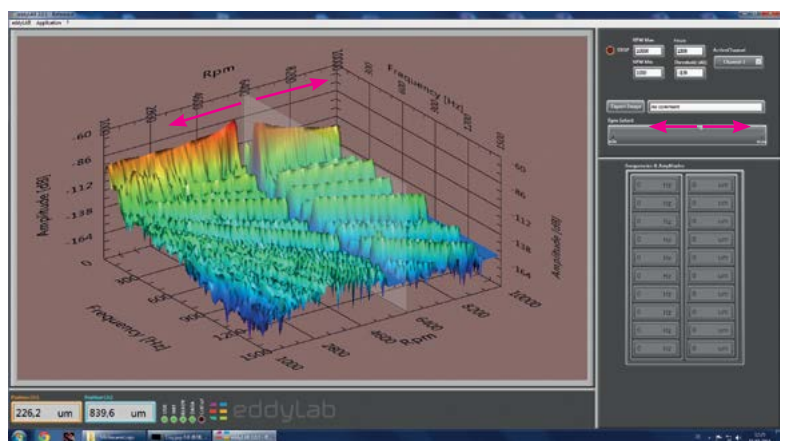
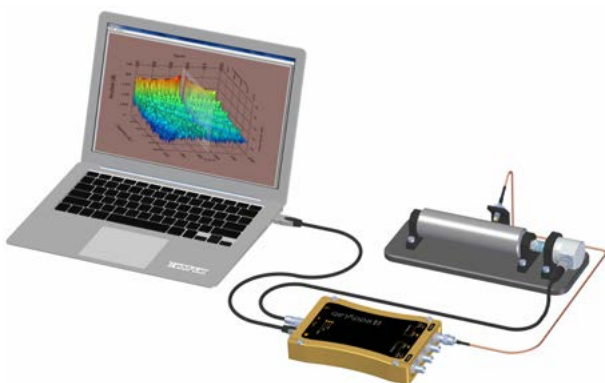

This function is only available in conjunction with a rotational incremental encoder. This admits the determination of the rotational speed of a rotating shaft. The FFT is expanded with a rpm axis. The correlation of rotational speed and FFT results in a characteristic 3D-plot. The plot may characterise the state of a rotating system depending on loads, oil-pressure, wear and similar aspects.

- spectrum like the two-dimensional FFT expanded with a rpm axis
- scalable frequency axis
- 3D-view can be rotated
- moveable analysis plane along the rpm axis
- detection of frequencies and amplitudes within the analysis plane
- export as image

Function	eddylab Lite	eddylab Standard	eddylab Reference
Oszilloscope	x	x	x
FFT		x	x
Data logger		x	x
Waterfall		x	x
Linearisation			x
Waterfall-RPM			x

TECHNICAL DATA - PROBES



Probe	T05	T2	T3	T4	T5	T10
range [mm]	0...0.5	0...2	0...3	0...4	0...5	0...10
range extended [mm]*	1	2.5	4	5	7	12
housing size	ø5	ø8	ø12	ø14	ø18	ø30
offset gap (blind range)	~ 0.01 mm					
linearity	± 0.15 % of range					
resolution reg. corner frequency [% FS]**	dependent on the distance (see resolution diagram on page 7), valid for middle of range					
10 Hz	0.006	0.01	0.006	0.007	0.007	0.006
100 Hz	0.008	0.015	0.008	0.008	0.007	0.007
1 kHz	0.021	0.035	0.021	0.014	0.014	0.015
10 kHz	0.075	0.061	0.040	0.033	0.047	0.045
35 kHz	0.101	0.088	0.078	0.064	0.075	0.078
temperature range sensor	-60...185°C					
temperature coefficient sensor	dependent on distance (see temperature coefficient diagram on page 7)					
sensor cable PTFE-COAX	ø1,8 mm		ø2,5 mm (max. 2.7 mm)			
cable length	standard length 3 m / 6 m, customised length up to 20 m					
min. bend radius static/dynamic	10/25 mm			15/37 mm		
temperature range cable	-55...+200 °C					
connection	BNC connector / optional SMB connector					
protection class	IP68					
vibration	20 g, DIN EN 60068-2-6					
shock	100 g / 6 ms, DIN EN 60068-2-27					
check resistance [Ω]	6	8	9	12	12	9
housing material	stainless steel 1.4305, sensor head PEEK (polyetheretherketon), FPM bend protection					

* linearity and resolution are not valid for extended measurement ranges

** 98.5% confidence interval (confidence limit), middle of range as % of range. Resolution dependent on the distance (see „Resolution and Temperature“ on page 8)

Cable configuration

By default the probes have a BNC plug for the connection at the TX-Driver. Optionally the probes are equipped with a SMB connector. The SMB connection is either performed as BNC-SMB adapter (Version 1) or as a SMB-COAX cable extension (Version 2).

Please note:

The SMB connectors have beryllium copper contacts. The connector housing is gold plated and has an outer diameter of 6.5mm. This facilitates the installation in particular with narrow conditions (Version 1). If the cable is durably affixed it might be desirable only to remove the probe from the entire cable (Version 2).

It is recommended to avoid unnecessary connections within the cable as it increases the probability of failure due to environmental influences such as wetness, dirt, aggressive media, massive vibration or shock.

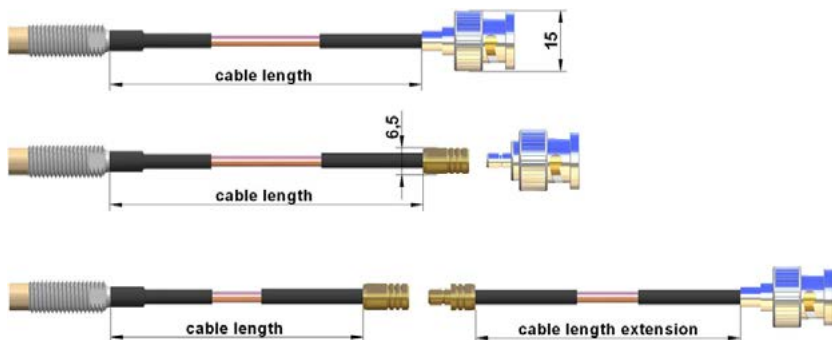

Standard version

- probe with BNC connector
- cable length 3 m (standard)*

Version 1

- probe with SMB connector
- cable length 3 m (standard)*
- BNC-SMB adapter for eddy current basic module

Version 2

- probe with SMB connector
- cable length 3 m (standard)*
- additional extension cable SMB-KOAX with cable length 3 or 6 m*. SMB connector to BNC connector.

*customised cable length up to 20 m in total

TECHNICAL DATA - EDDY CURRENT BASIC MODULE



Eddy Current-Basic Module	TX1	TX2
channels	1 channel	2 channel
operating temperature range	-40...+50 °C	
storage temperature range	-40...+85 °C	
humidity	95 % (no condensation)	
vibration	5 g, DIN EN 60068-2-6	
shock	15 g / 11 ms, DIN EN 60068-2-27	
protection class	IP40	
housing	anodised aluminium with plastic frame and rubber feet, stackable	
housing size L x W x H	195 x 116 x 29,5 mm	
weight	665 g	694 g
Optionaler Referenzeingang		
Hilfsspannungsausgang (für DK-Taster oder Encoder)	5 V Maximalstrom 250 mA	
Signaltyp	A / B Pulse (RS422)	
Supply		
Supply Voltage	10.5...36 VDC Wide Input; 10.5...27 VDC Ref-Version	
current consumption	145 mA (24 V), 260 mA (12 V), 300 mA (10.5 V)	150 mA (24 V), 300 mA (12 V), 380 mA (10.5 V)
Stromaufnahme mit Referenzaster der DK-Serie	170 mA (24 V), 300 mA (12 V), 340 mA (10.5 V)	180 mA (24 V), 340 mA (12 V), 390 mA (10.5 V)
power on peek current	350 mA (24V), 470 mA (10,5V), < 30 ms	
reverse polarity protection	yes	
protection circuit	bipolar suppressor diode 36V / polyfuse 0.5A	
isolation voltage	mind. 1 kV	
Analogue output		
output signals	0...10 V / 0...5 V / ±5 V / 0...20 mA / 4...20 mA	
dynamic / sampling rate	124 kSa/s	70 kSa/s
dyn. / samp. with simultaneous USB usage	76 kSa/s	45 kSa/s
filter corner frequency	10 Hz / 100 Hz / 1 kHz / 10 kHz / 35 kHz (-3 dB)	
max. working resistance (current output)	< 400 Ohm	
temperature coefficient electronic	-0.025 %/K	
switching-on delay (boot-time)	3.1 s	
switching-on drift	< 1% (see diagram)	
connection	1 x BNC female connector	2 x BNC female connector
output protection circuit	polyfuse 50mA	
General data and industrial standards		
electromagnetic compatibility	EN 61326-1 / EN 55011	
RoHS	appropriate standard 2002/95/EG	
MTBF	EN 61709, > 360.000 h	
customs declaration number	90318034 country of origin Germany	

RESOLUTION AND TEMPERATURE

Resolution nm...µm

The probe's resolution depends on the selected corner frequency and the actual position. The best resolution is achieved within the first 50% of the measuring range.

The following charts illustrate the resolution as a function of the position (normalised) and the corner frequency. Low corner frequencies and positions close to the target result in high resolutions.

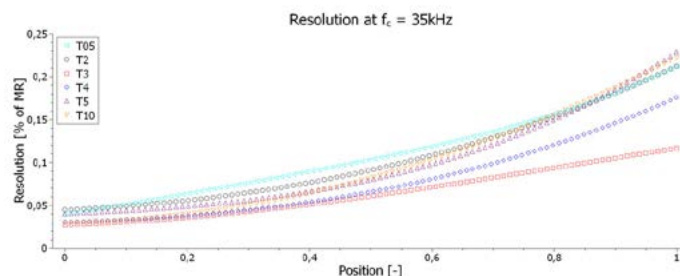
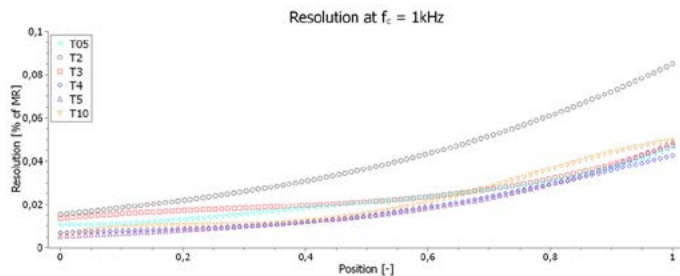
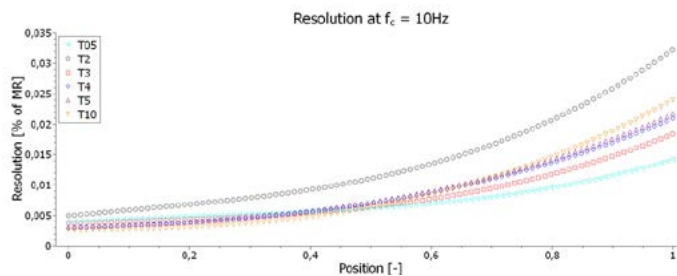
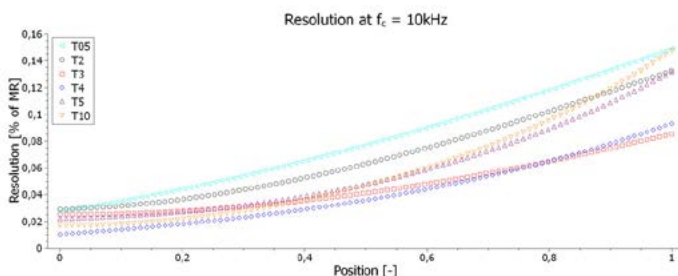
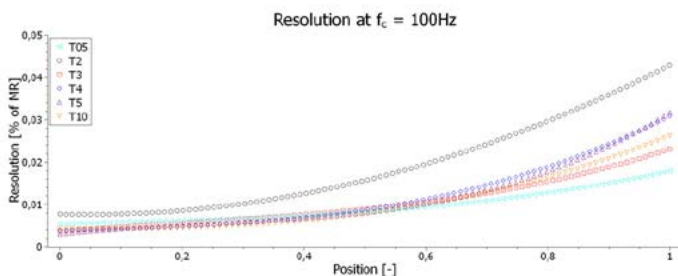

Temperature coefficient TC

The temperature coefficient has a severe impact on the precision and in particular the repeatability of measurements when exposed to temperature variation. eddylab probes have a remarkable temperature characteristic - the temperature coefficient is almost zero over wide ranges of temperature. The following charts document the temperature coefficient as a function of the actual temperature and the position. The best temperature behaviour is achieved at 50% of the measuring range. The temperature coefficients refer to a cable length of approx. 50cm.

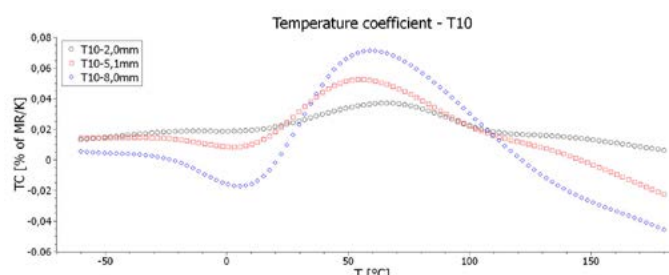
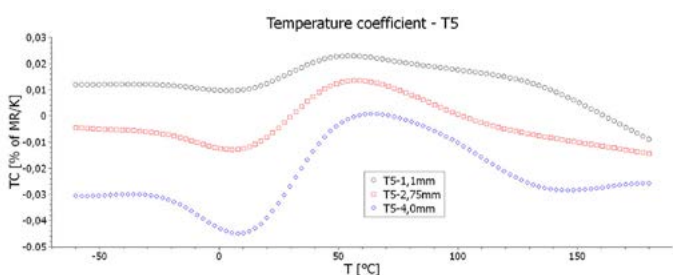
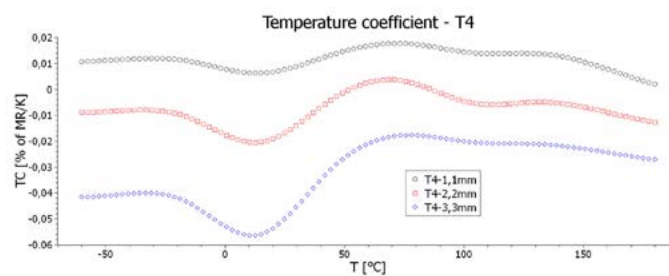
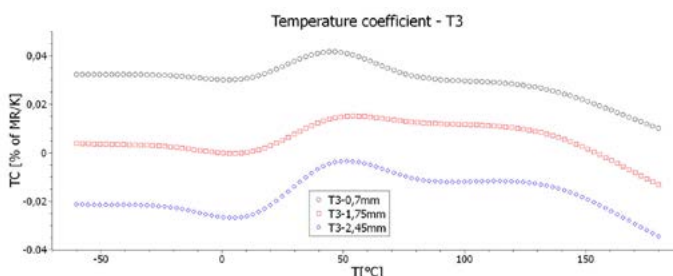
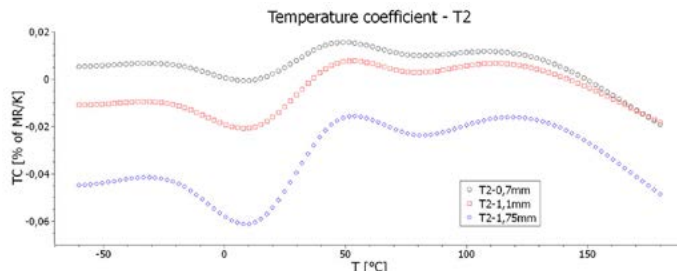
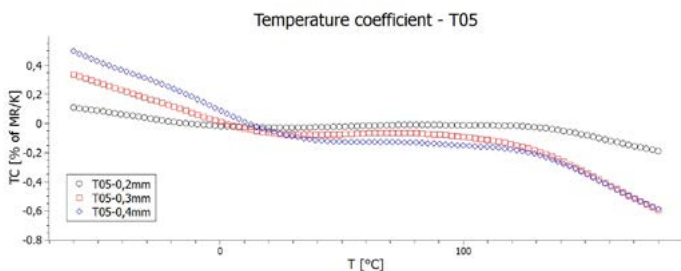

PROPERTIES

Device drift after power-on

For highly precise measurements the device drift after power-on has to be considered. The entire device drift is <1 % of the measuring range.

- ~ 0.1 % of MR at 30 min. warm up
- ~ 0.2 % of MR at 20 min. warm up
- ~ 0.4 % of MR at 10 min. warm up
- ~ 0.8 % of MR without warm up

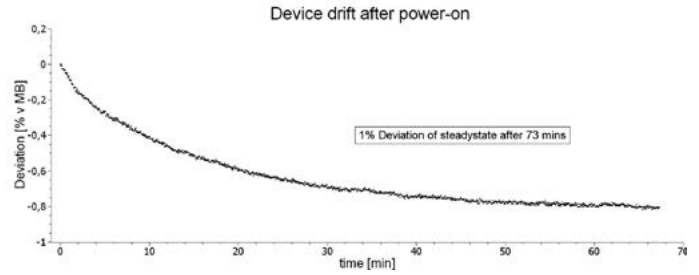

Frequency response

The TX Series contains a hardware filter with a corner frequency of 50 kHz in its signal path. Additionally five user selectable software filters can be set. The chart illustrates the respective characteristic. Lowering the corner frequency increases the resolution. Note that higher frequencies will appear attenuated.

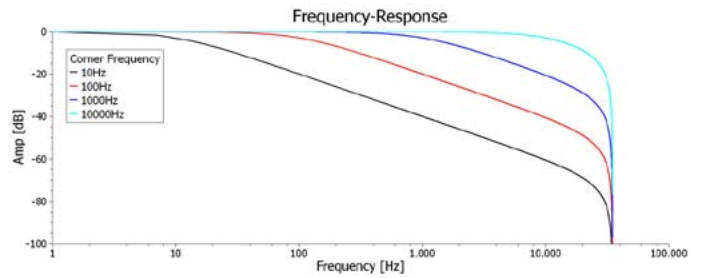

Zero TC measurements - Procedure:

The exceptional temperature behaviour of our probes allows zero TC measurements. That means the position won't be affected by temperature effects. Consider the following five aspects:

- 1) Only the probe is exposed to temperature.
- 2) The probe cable must be located predominantly outside of the temperature influenced area and must not be laid on parts of machines, etc., subject to temperature fluctuations. Consider this for installation.
- 3) The eddy current basic module must be placed outside any temperature influence or variation. The device must be powered 60 min before measurements commence.
- 4) The measurement has to be taken in middle of the entire measurement range.
- 5) The zero TC effect is only valid for temperatures on the zero TC line with same positive and negative area (see chart).

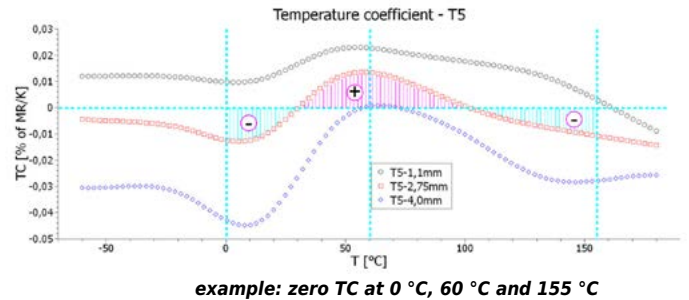

CALIBRATION

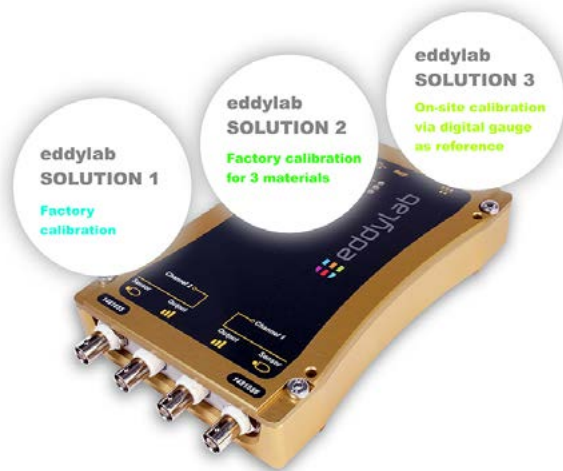

The following variants of calibration are available:

1. Factory calibration for one material incl. certificate.
2. Factory calibration for three different materials. The materials are chosen with eddylab lite/standard/reference incl. three certificates.
3. Factory calibration incl. certificate plus customer based linearisation on-site with a digital gauge and eddylab reference (requires REF option for the TX-driver). The accuracy behaviour of an eddy current sensor can be proved and improved on-site with a digital gauge as reference.

materials to choose from for calibration

16MnCr5	1.2379	AlMgSi0,5
42CrMo4	1.2738	AlMg4,5Mn
St52	1.4301	AlMgCuPb
C45E	1.4305	9SMn28k

also eligible for calibration: zinc plate, titanium, carbon fiber

All of our probes are tested and calibrated before shipping. The calibration is based on 50 positions. Every probe has a unique setup - therefore the probes may not be interchanged among different drivers.

The certificate of calibration contains the measured and reference data, the sensitivity, the target material and the linearity as a chart. The certificate of calibration is provided as standard - but it is also available subsequently.

Target - material

Eddy current measurements depend on the target's conductivity and permittivity. The default material for factory calibration is steel of type 16MnCr5. Calibration is also possible with other conductive material such as aluminium, titanium, carbon fibre etc.

The following list shows available material for calibration. If you desire to use a different material we recommend to provide a probe (50x50mm) for calibration.

USB / CAN / REFERENCE INPUT / CONNECTION

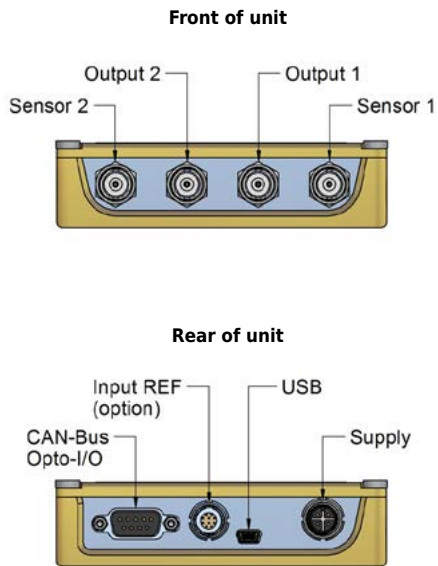

Pin	Name
1	A
2	A
3	B
4	B
5	Z
6	Z
7	0V
8	Vcc
9	Vsense
10	n. c.

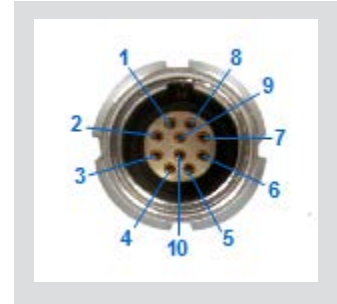

USB

The eddy current basic module provides a USB port (USB 2.0 High Speed).

- sampling rate 38 kS/s (single channel), 22,5 kS/s (dual channel)
- device configuration (filter, linearisation, CAN bus)
- data exchange with a PC or notebook via eddylab Windows software or via protocol

Sampling rates	TX1	TX2
Analogue without USB	124 kSa/s	70 kSa/s
Analogue with USB	76 kSa/s	45 kSa/s
USB	38 kSa/s	22,5 kSa/s



CAN-Bus

The TX-Driver also provides a CAN-bus interface (controller area network).

- data transfer rate 1 MBit, standard-identifier
- triggers: internal timer, remote request, sync.
- networking of many devices with minimal wiring effort
- highly reliable data transfer over wide ranges – ideal for applications with many devices (consider dynamics)
- economisation of analogue measuring equipment (analogue-to-digital converter)

Wiring is achieved with a CAN-bus cable. The first and the last device on a CAN bus must be terminated.



Digital IN OUT/CAN (D-SUB 9-pole MALE)

Pin	Name	Description
1	EXT OPTO OUT 1	digital output I/O 1
2	CAN L	CAN low signal
3	CAN GND	CAN ground
4	EXT IN 1	digital input I/O 1
5	EXT IN 2	digital input I/O 2
6	IN GND	ground I/O
7	CAN H	CAN high signal
8	EXT OPTO OUT 2	digital output I/O 2
9	n. c.	n. c.

Supply via a 4-pole M12 plug connector (socket)

View of the unit and the soldering side of the mating connector.

- Pin 1 (brown) = +V (supply 10.5...36 (27) VDC)
- Pin 3 (blue) = GND

For connecting the power, shielded cables in various lengths are available (see accessories).

Please use only shielded supply cables and set the screen on one side (to avoid ground loops)!

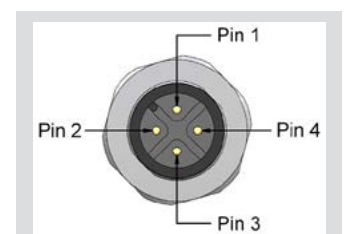

TECHNICAL DRAWINGS

Typ T05

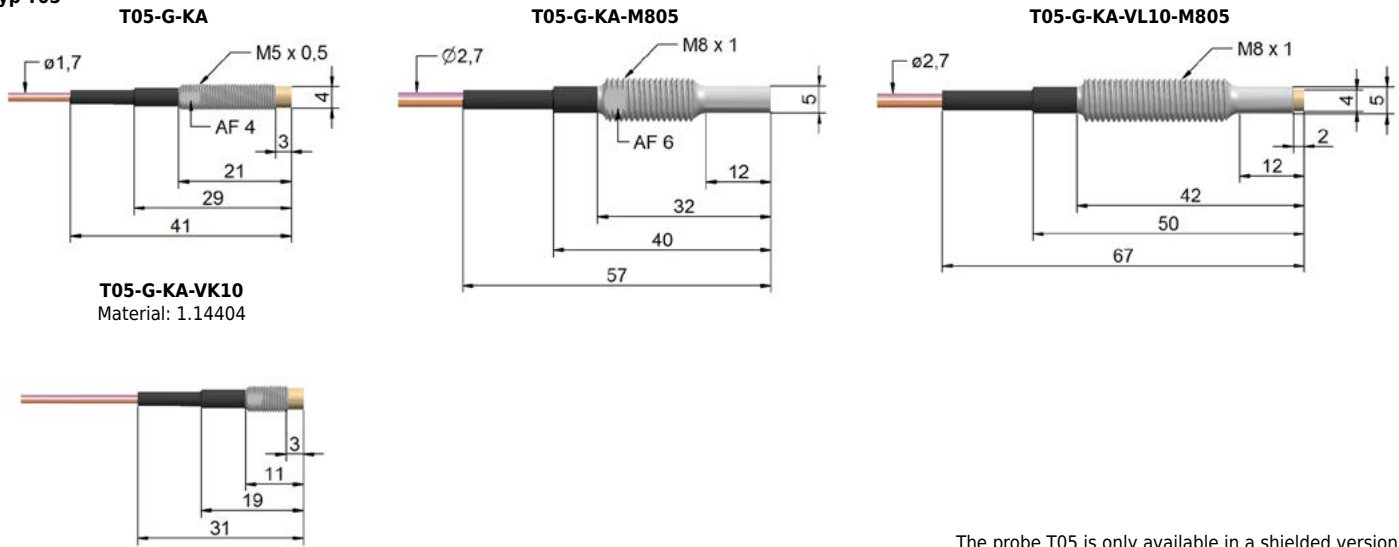

The probe T05 is only available in a shielded version.

Typ T2

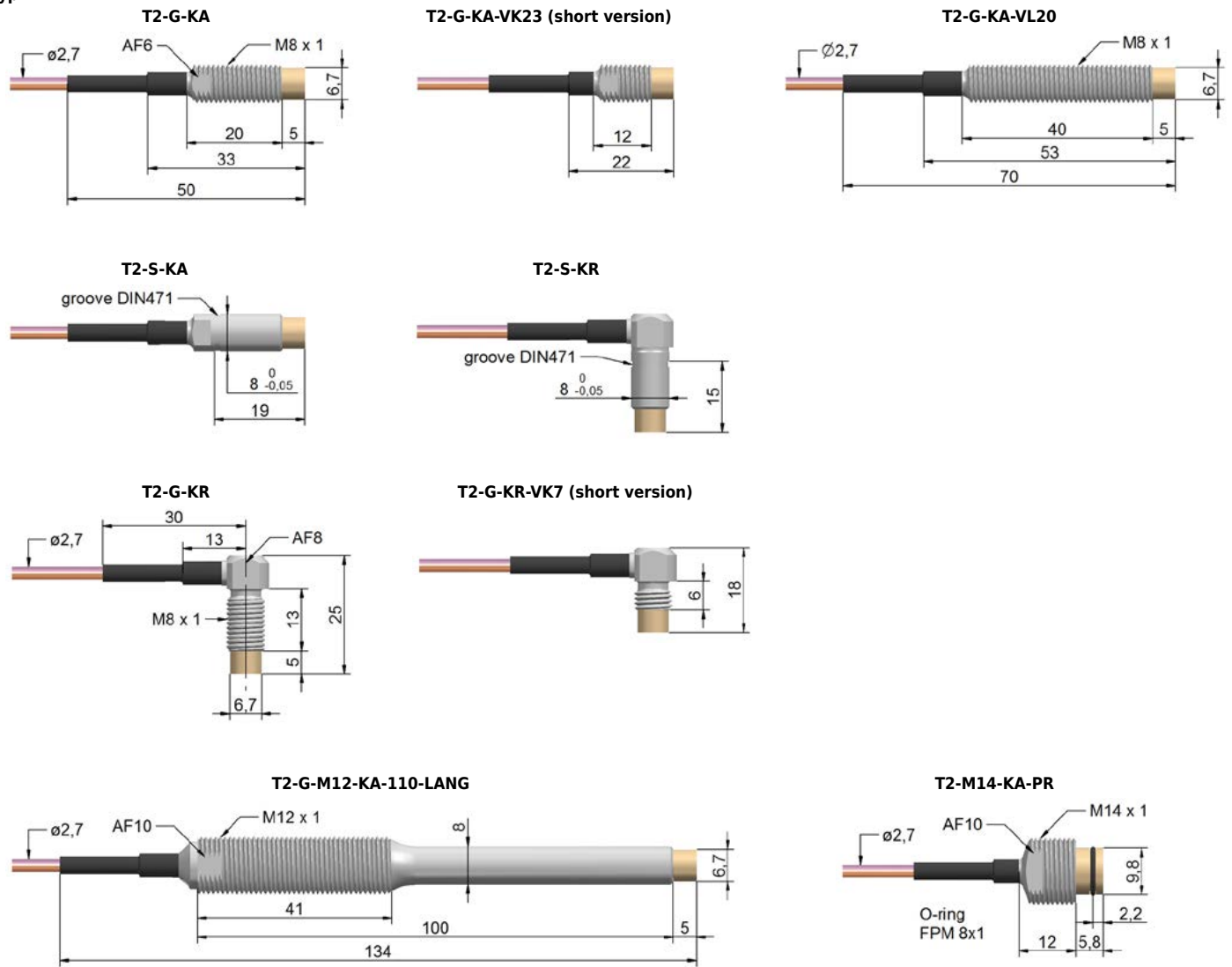

TECHNICAL DRAWINGS

Typ T3

T3-S-KR

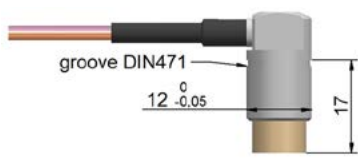

T3-G-KA

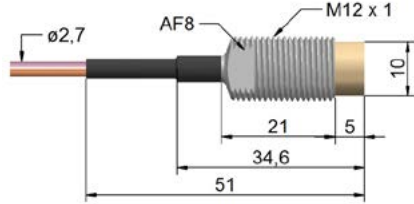

T3-FL-M1205-KR (flange version)

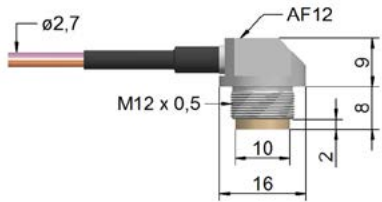

T3-G-KR

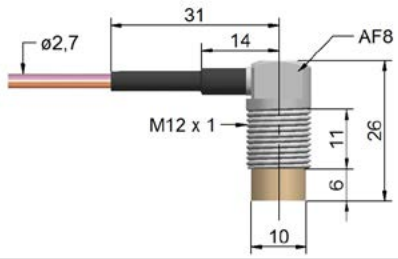

T3-G-KA-VL10

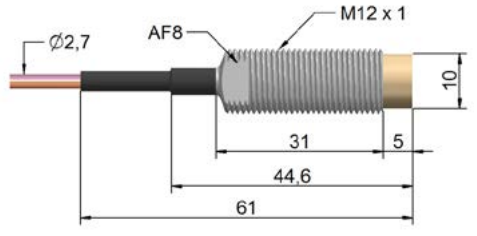

Typ T4

T4-G-KA

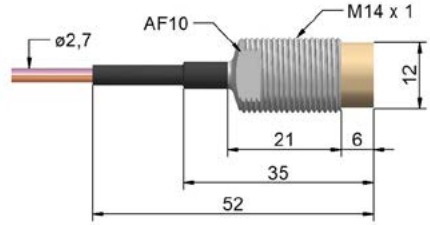

Typ T5

T5-G-KA

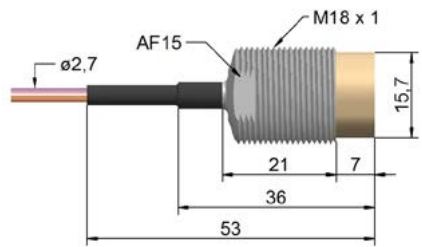

T5-DSC-KR

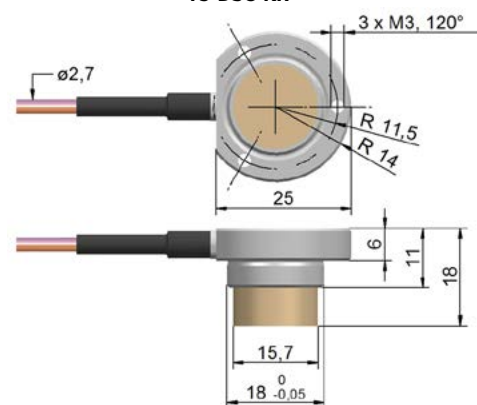

T5-G-KR

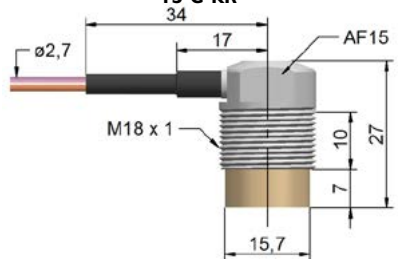

T5-S-KR

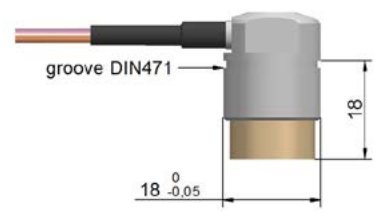

T5-G-KR-VL10

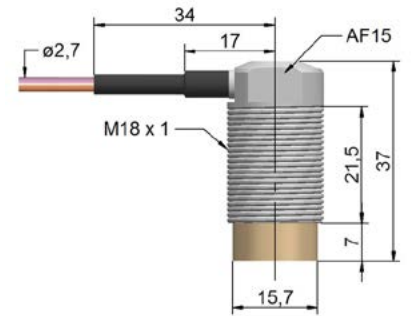

Typ T10

T10-G-KA

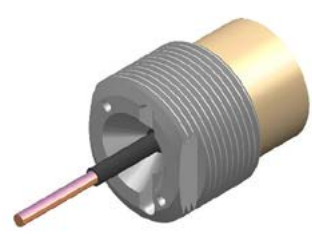
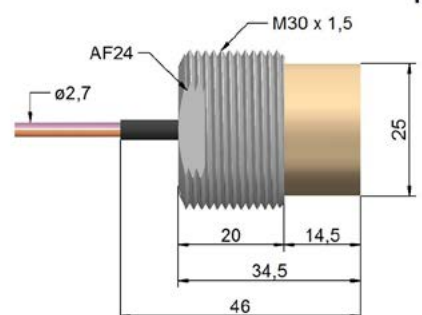

TECHNICAL DRAWINGS

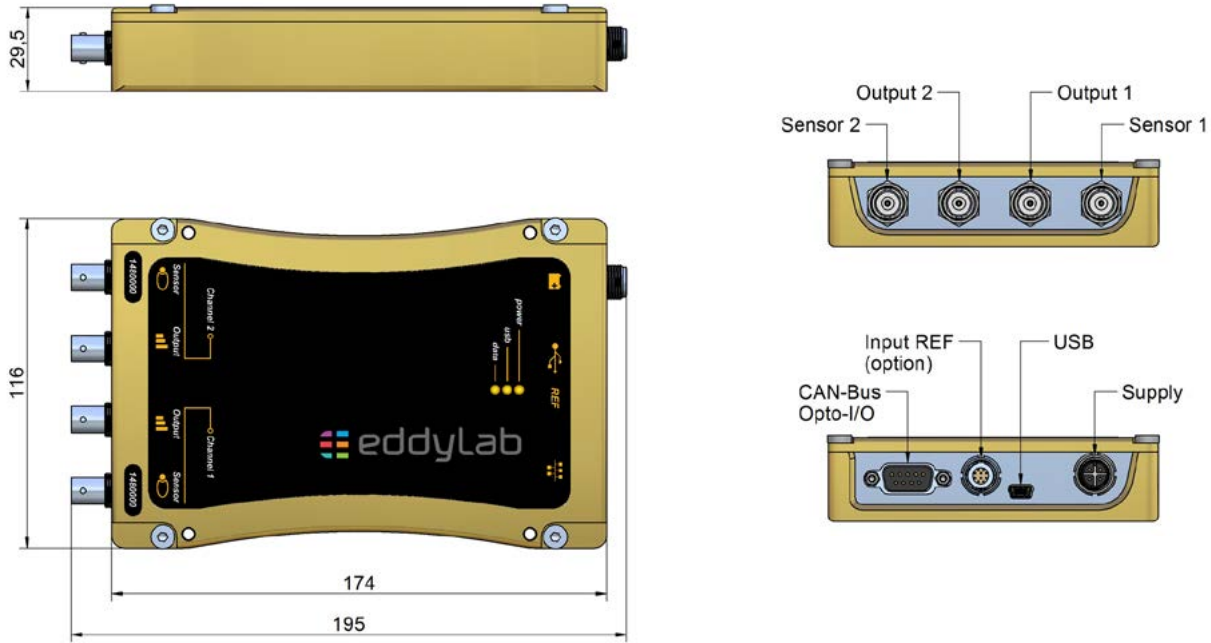

ACCESSORIES

eddylab

Powerful Windows software incorporating six major functions:

Oscilloscope, FFT, Data logger, Waterfall an Waterfall-RPM and Linearisation. (Details on pages 4-5)

Delivery contents: software-CD, gold-plated USB cable, dual shields incl. 2 ferrites, length 1.8 m

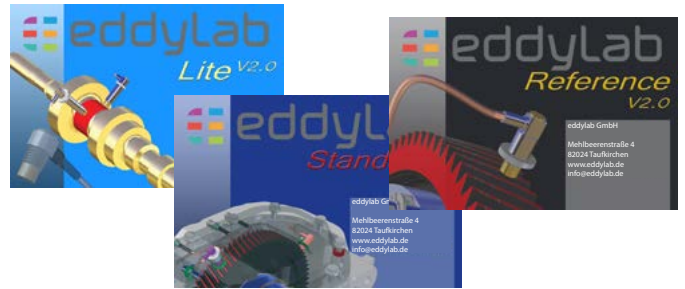

Digital gauge (DK-Series)

- Resolution: 0.1µm
- Accuracy: 1µm
- Output signal A/B reference point, TTL-linedriver according to EIA-422
- Displacement speed up to 250 m/min
- Working temperature 0..50°C
- Protection class IP67
- Easy mounting
- Resistant against water and oil



Adapter cable for DK-Series / Reference input

- Interface cable for the DK-Series on the TX-Driver
- Available lengths: 1 m, 3 m, 5 m

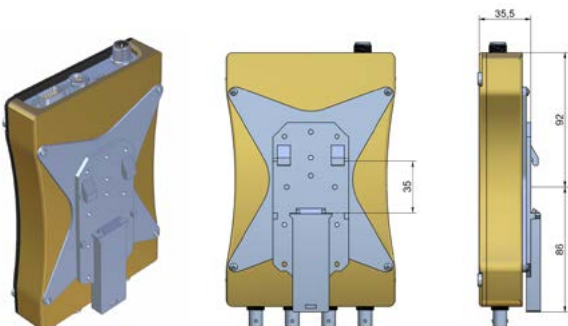

DIN rail connector

The DIN rail connector provides an easy and secure mounting of the TX electronics in a switch cabinet by simply snapping it onto a 35 mm DIN rail (DIN50022).

Disassembling can be done by pulling the easy accessible latch.

Stacking of several electronics can save lots of space in the switch cabinet. Therefore, please use the included housing connectors.

ACCESSORIES

Cable for power supply with mating connector M12 straight and angled - K4P

Cable with straight connector:		Cable with angled connector:	
K4P2M-S-M12	2 m	K4P2M-SW-M12	2 m
K4P5M-S-M12	5 m	K4P5M-SW-M12	5 m
K4P10M-S-M12	10 m	K4P10M-SW-M12	10 m



BNC measurement line for the analogue output (Multi-Contact)

XLSS-58

Touch-safe coaxial measurement line. BNC connectors on both ends. Connectors have nickel plated shields and gold plated pins.
length 2 m, temperature range -10...+70 °C
capacity 219 pF, inductance 680 nH, wave impedance 50 Ω



XLAM-446/SC

Highly flexible, entirely shielded measurement line. Touch-safe BNC connector on one end and two stackable Ø 4 mm connectors on the other end.

length 1.6 m, temperature range -10...+70 °C
capacity 240 pF, inductance 1000 nH



Cable extension SMB-KOAX

Additional extension accordingly to option 2 (see page 6 below). SMB connector to BNC connector.

3 m length: SMB-KOAX-3M
6 m length: SMB-KOAX-6M



Note: for probes with SMB connectors only. The probe is calibrated with an extension that can be ordered additionally. Optional operation without extension is then no longer possible.

Wall plug transformer for the TX-Driver

nominal input voltage	100-240 VAC, 50-60 Hz
output voltage	12 VDC ±5 %
output current	500 mA
temperature range	0...+40 °C
protection class	IP40
cable length	2 m
terminal	M12-plug Pin1=+, Pin3=GND



Rail-power supply 24 VDC PS-100-240AC/24DC/1.3

Extra narrow power supply - only 22.5 mm wide. Reliable start-up of several eddy current basic devices is guaranteed by a 100% power boost.

Reliability is also achieved on difficult global networks. The supply will remain stable even if transient or static voltage failure occurs. Well dimensioned capacitors bypass power failures of more than 20 ms.

nominal input voltage	100-240 VAC, 45-65 Hz
output voltage	24 VDC
output current	1.3 A (max. 1.6 A)
temperature range	-25...+60 °C
power failure bypassing	> 110 ms (230 VAC)
efficiency	> 85 %
protection class	IP20

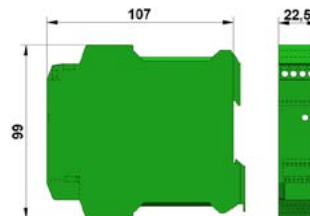

ACCESSORIES

Linear stage

Portable linear stage for the usage on-site

- Newport linear stage
- prism shaped socket for eddy current sensors
- 8 mm slot for linear encoders
- quick release socket for different targets (smallest dimension 50x50x5mm, largest dimension 70x70x5mm)



INSTALLATION

Electrical installation

Choose a dry location, preferably with a stable temperature for the electrical installation (TX-Driver) such as electrical cabinets, terminal boxes, housing, etc.



Connect the supply line, probe lines and output lines. Please ensure that all supply and signal lines are laid separately from energy-carrying lines such as supply and discharge lines from converters and drives, lines from ovens and synchronised appliances or generator lines, etc., in order to avoid malfunctions in the signal behaviour.

Please use shielded supply lines only and apply the shield to one side to avoid ground loops.

Please observe the correct assignment of the probes to the respective basic modules and channels. Each individual channel is aligned by the probe as a pair.

Probe installation

Firstly, install the probe at the relevant installation location and affix the probe using jam nuts or clamp mechanisms. After you have installed the probe, lay the cable. Ensure that the cable is laid without dents and is not placed under stress. After you have laid the cable into place, do not turn the probe out of the thread, so as to prevent cable damage arising from stress. Secure excess probe cable as far away from temperature influences as possible, i.e. away from electronics. Never shorten the probe cable!

Please note that the probe head must be kept free from surrounding conductive objects. In order to avoid pre-attenuation of the measuring system - stick to the following mounting guidelines. In the case of installation into non-metallic and non-conductive materials this is not necessary.

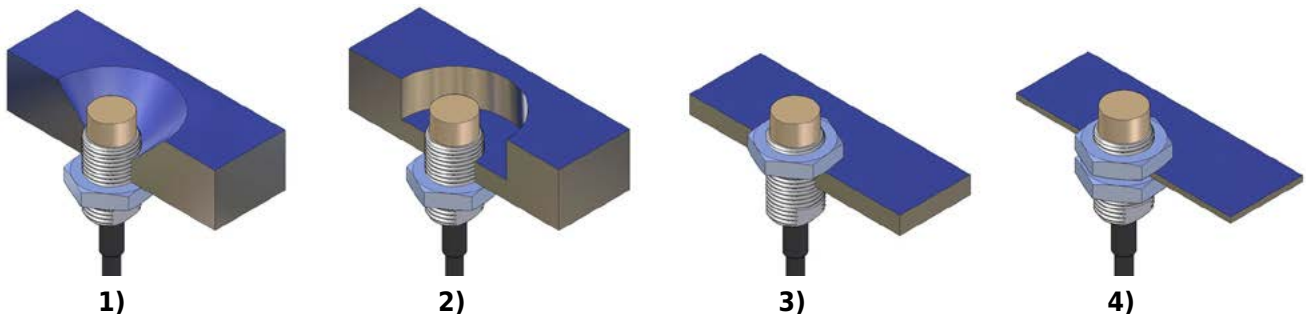

- 1)** Installation with 45° countersinking. The diameter of the countersinking must be at least three times greater than the probes head diameter.
- 2)** Installation with cylindrical countersinking. The diameter of the cylindrical countersinking must be at least 2-3 times greater than the probes head diameter. The projection of the probe and the cylindrical bottom must be at least three times the measuring range - however at least the length of the PEEK head.
- 3) + 4)** Installation into plates or sheet metal with front or rear jam nut. Ideally, ensure there is an additional thread projection of approx. 3 mm to the board or the jam nut. Please note that thin-walled holders can oscillate or vibrate and the holder's own frequency can interfere with the measurement result. If these locations cannot be kept free of impairment as recommended it is recommended that a ferrite-shielded probe or a customer-specific linearisation is used. Ferrite-shielded probes are available upon request.

Recommended pressure-tight installation

Some standard units can be installed in a pressure-tight manner to withstand system pressure of up to 50 bar by using a PEEK connector with O rings (see the image on the right). In the case of greater pressure areas, we can produce pressure-tight units as required.

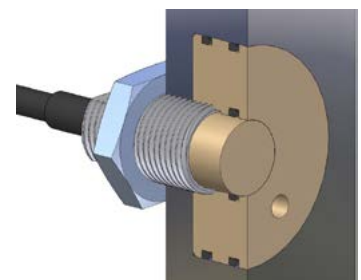

INSTALLATION

Object size and the eddy current measurement field

The sensing electromagnetic field (illustrated in red) is emitted elliptically from the probe and is greater than the probe head in terms of its spatial expansion. For standard-calibrated probes a surface with a target diameter 2-3 times greater than the probe head diameter is necessary for measurement. If the object is too small, only a part of the measurement field enters the material, and the output signal becomes larger. If the diameter is too small, the object appears to be further away from the sensor. A similar effect takes place in the case of round objects.

However, if other conductive objects collide with the sensing electromagnetic field the output signal is reduced due to pre-attenuation. The actual object appears to be closer to the probe. If this signal alteration is not desired, we provide a customer-specific linearisation for such applications. In this case, the probe is calibrated within the pre-attenuating environment. The measuring system will fulfill the standard specification. The object (shape, material) is documented in the calibration document.

The following pictures provides an overview of various geometrical arrangements:

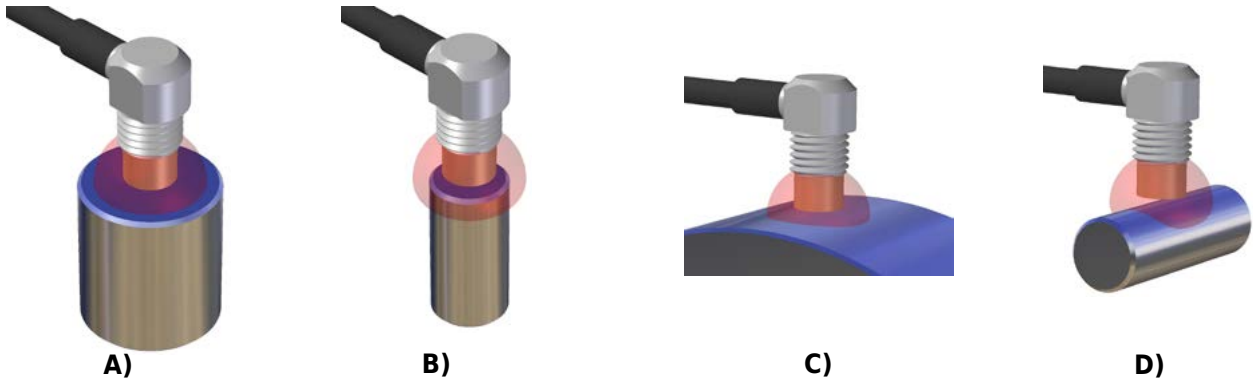

A) Optimum object surface preferably 2-3 times greater than the probe head diameter. The sensing field is captured by the object entirely.

B) Reduced object surface - a part of the sensing field remains outside the object. The probe displays a greater distance signal than the actual distance. The measurement area is reduced in size. Lateral object movements can influence the distance signal. We can perform a customer-specific linearisation in order to correct the measuring range and the linearity.

C) Large round objects (diameter $> 8 \times$ probe head diameter) such as cranks or shafts can be captured without significant signal alterations. The probe outputs the medium distance via the captured surface. The measuring range will be reduced by $< 10\%$. To correct this an optional customer-specific linearisation is available (pages 4-5).

D) Small round objects such as shafts or wire (diameter $< 2 \times$ probe head diameter) can only be captured with a significantly smaller measuring range as long as customer-specific linearisation has not taken place. For example: shaft diameter $< 2 \times$ probe head diameter \leftrightarrow reduction in the measuring range of $\sim 25\%$, linearity $\sim 5\%$. In this case we recommend a linearisation.

Conductive objects in the sensing field

Please note that conductive objects such as screw heads, bolts, etc., located in the sensing field in both - radial and axial direction (or which cross the sensing field during rotation) can become disturbance variables in the signal.

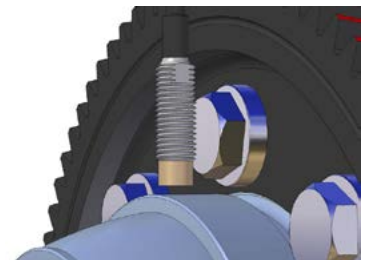

ORDER CODE

Probes	
T05-G-KA	Probe with 3m cable / BNC-connector
T2-G.. / T2-S..	Probe with 3m Kabel / BNC-connector
T2-M12-KA-110 LANG	Probe with 3m Kabel / BNC-connector
T3-G.. / T3-S..	Probe with 3m cable / BNC-connector
T3-FL-M1205-KR	Probe with 3m cable / BNC-connector
T4-G-KA	Probe with 3m cable / BNC-connector
T5-G-- / T5-S..	Probe with 3m cable / BNC-connector
T5-DSC-KR	Probe with 3m cable / BNC-connector
T10-G-KA	Probe with 3m cable / BNC-connector
TX-Drivers	
TX1	1-channel, Analogue output + USB + CAN
TX2	2-channel, 2 x Analogue output + USB + CAN

OPTIONS

6M	cable length 6 m
9M	cable length 9 m
12M	cable length 12 m
15M	cable length 15 m (not available for T05)
SHIELDED	shielded probe
SMB	probe with SMB connector
ER	extended range
TX-Driver	
REF	Referenzeingang / RS422
CAL-TX	Factory calibration for each additional material

CABLE CONFIGURATION (see page 6)

Standard
probe with BNC connector
Version 1: probe with SMB connector and BNC/SMB adapter
please order: Option SMB + BNC/SMB (accessory)
Version 2: probe with SMB connector and extension cable for SMB connector
please order for 3 m extension cable: Option SMB + SMB-KOAX-3M (accessory)
please order for 6 m extension cable: : Option SMB + SMB-KOAX-6M (accessory)

ACCESSORIES

SMB-KOAX-3M	extension cable for SMB connector 3 m
SMB-KOAX-6M	extension cable for SMB connector 6 m
BNC/SMB	adapter BNC/SMB for connection to TX module

Power supply cable with M12 mating connector

K4P2M-S-M12	2 m, straight connector
K4P5M-S-M12	5 m, straight connector
K4P10M-S-M12	10 m, straight connector
K4P2M-SW-M12	2 m, angular connector
K4P5M-SW-M12	5 m, angular connector
K4P10M-SW-M12	10 m, angular connector

Digital gauge - accessories

Sensor DK812SBR	Resolution 0,1 μm , accuracy < 0,5 μm
Sensor DK812SBR5	Resolution 0,5 μm , accuracy < 0,75 μm

Adapter cable DK-Series / Reference input

CE22-01-TX-REF	length 1 m
CE22-03-TX-REF	length 3 m
CE22-05-TX-REF	length 5 m
FGG.1B.310.CLAD52	connector for reference input

BNC measurement cables for the analogue output

XLSS-58	BNC into BNC, 2 m
XLAM-446/SC	BNC into $\varnothing 4$ mm curved, 1.6 m

Windows-software for USB

eddylab 2.0 Lite	software-CD
eddylab 2.0 Standard	software-CD, USB-cable 1.8 m
eddylab 2.0 Reference	software-CD, USB-cable 1.8 m

Power supply units

PS-100-240AC/24DC/1.3	24 VDC, 1.3 A / max. 1.6 A (DIN rail mounting)
PS-100-240AC/24DC/4	24 VDC, 4 A / max. 5 A (DIN rail mounting)
FW7662/12	12 VDC $\pm 5\%$, 500 mA (power supply for wall outlet)

Linear stage

Micro-KALIB-V1	Linear stage for the usage on-site
----------------	------------------------------------

TX housing connector

DIN rail connector	for TX housing
--------------------	----------------



Subject to change without prior notice.